



SCREENFLEX®
PORTABLE PARTITIONS

LIGHT DUTY PARTITION (3-PANEL) ASSEMBLY INSTRUCTIONS

STEP 1.

Remove two bolts from the outside-bottom edge of each outer panel with the included Allen key and one screw from the side of each outer panel with a Phillips screwdriver (not included).

STEP 2.

Attach the foot base with the three washers first (against the bottom edge of the panel), then the bolt. Repeat for the other set of washers and bolt.

STEP 3.

Attach the screw.

STEP 4.

Repeat Step 2 and Step 3 for the other side of the divider and foot base.

HARDWARE INCLUDED:

- (COUNT: 2) Feet with Wheels 
- (COUNT: 2) Screws 
- (COUNT: 4) Button Bolts 
- (COUNT: 12) Washers 
- (COUNT: 1) Allen Key 

Questions or concerns?
Please contact us at 1.855.960.6020
or email customerservice@screenflex.com

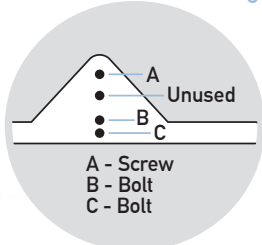
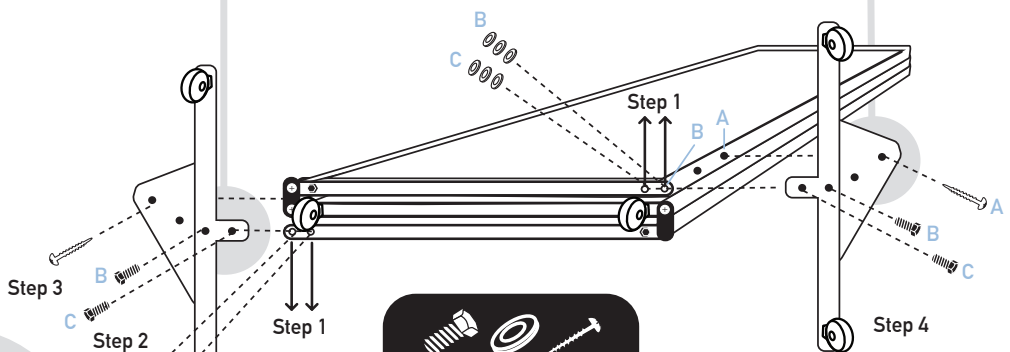

Important:
All bolts, washers,
& screws must be
reinserted in feet
brackets for
proper use.



TO LEARN MORE:
Call 855.960.6020 | For warranty info, email customerservice@screenflex.com